



© 2000 by F.Prudenziati



ENLARGED AND MODIFIED BY GABRIELE MACRI'
FOR FLYING SCALE MODELLING



FIREWALL
Glue on 3 mm ply

PRINT THIS PAGE ON 80 g/mq PAPER
PRINT FOLLOWING PAGES ON 150 g/mq



f



f



e



n2

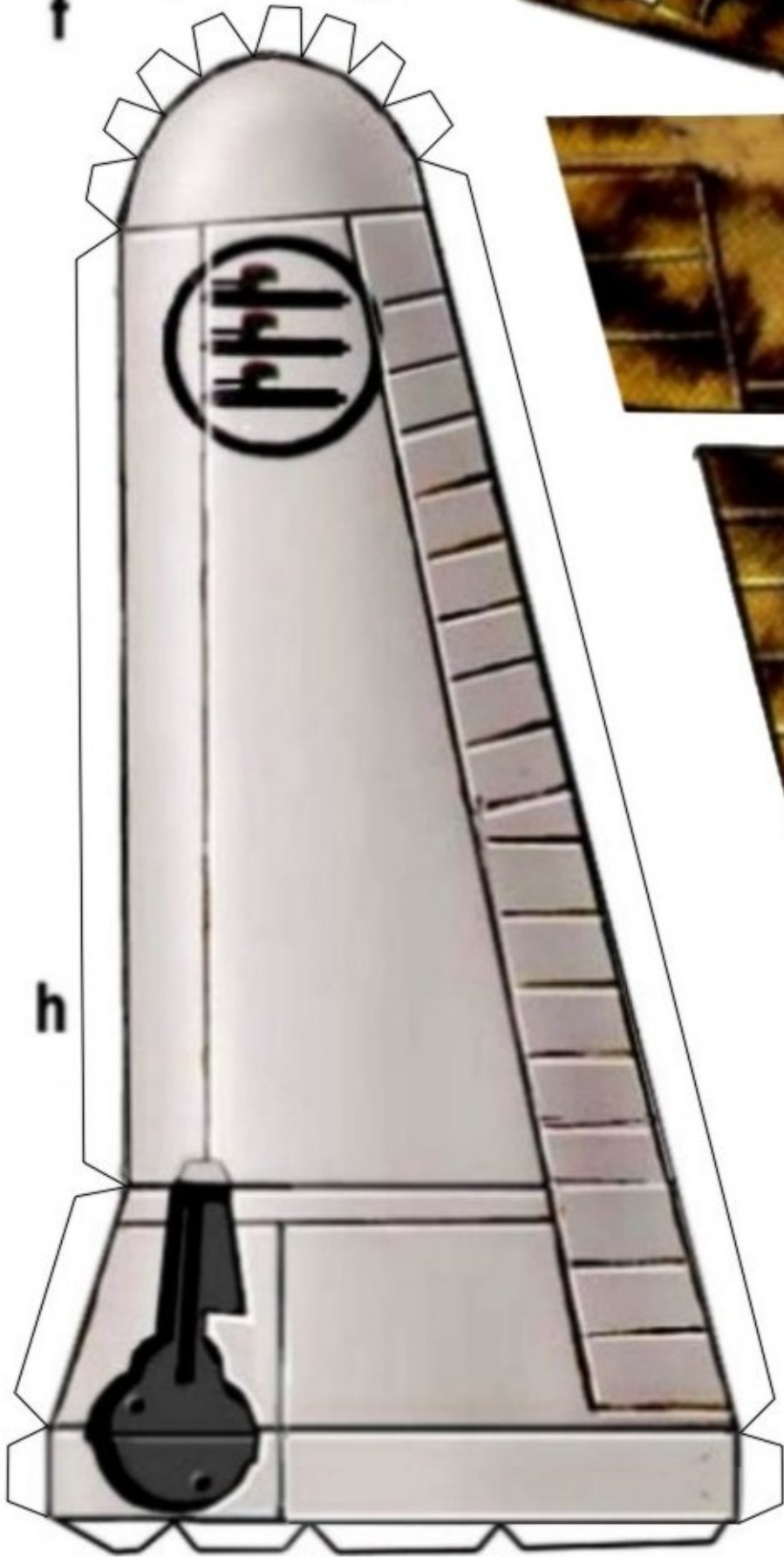

h

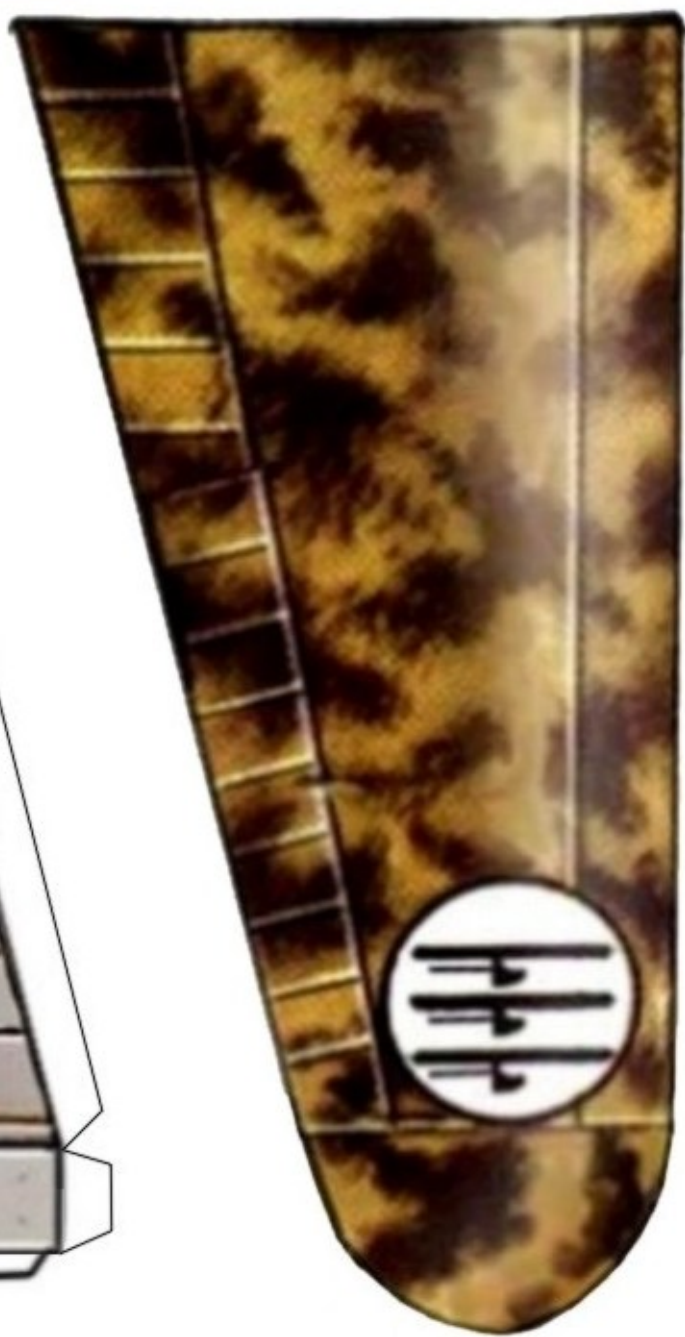

p

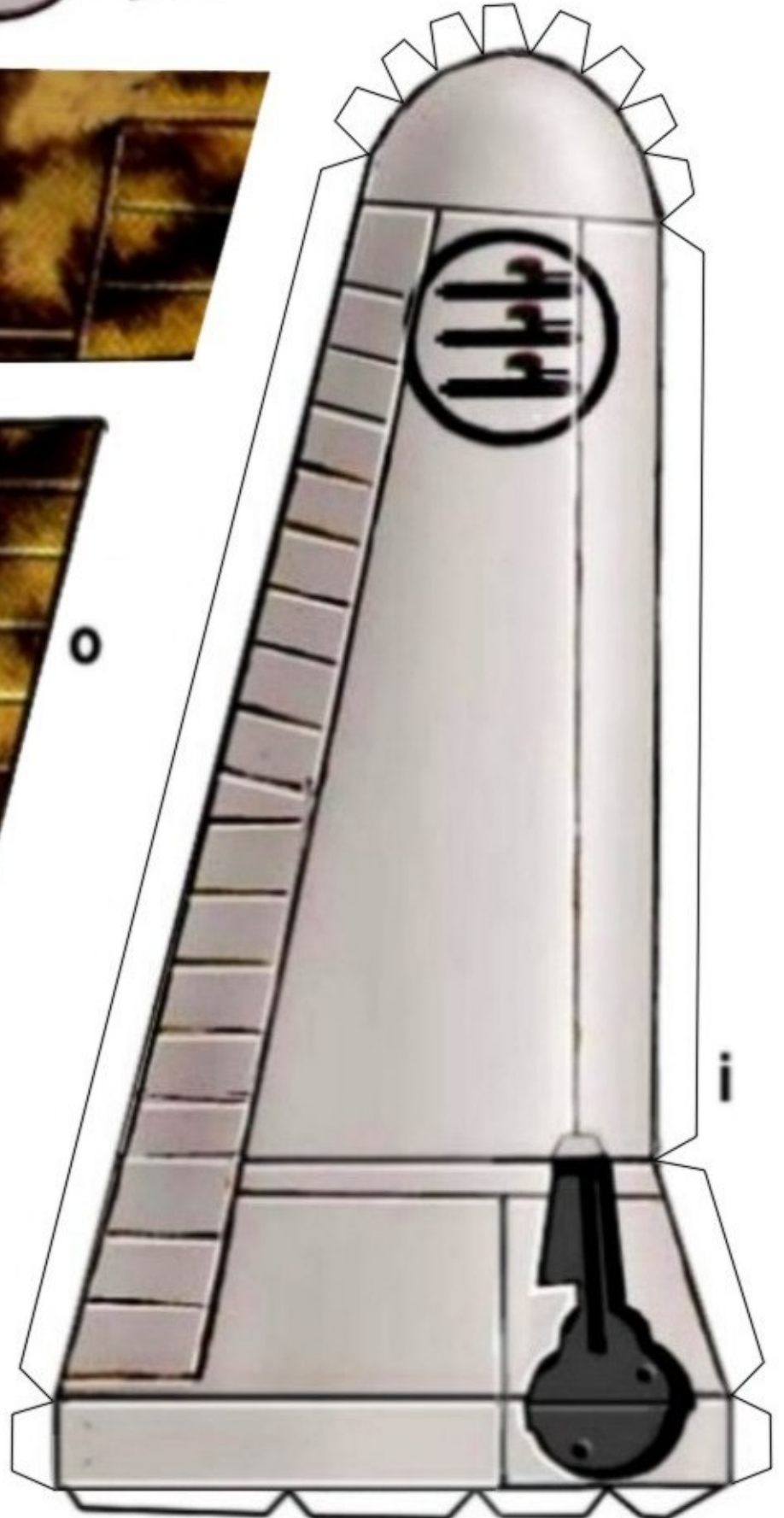
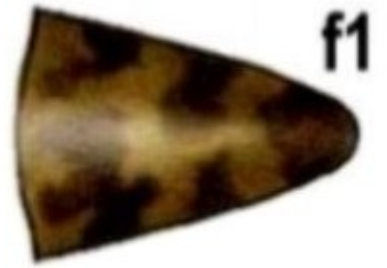
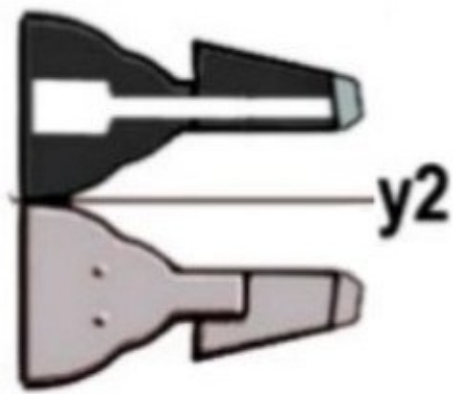
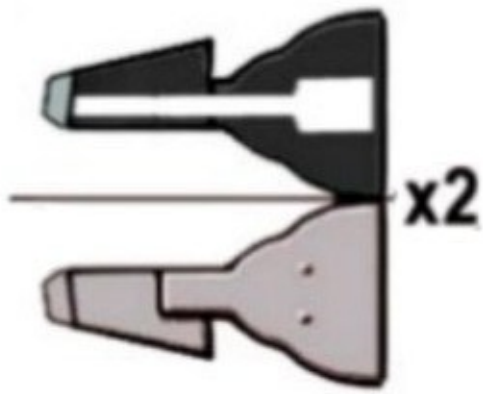

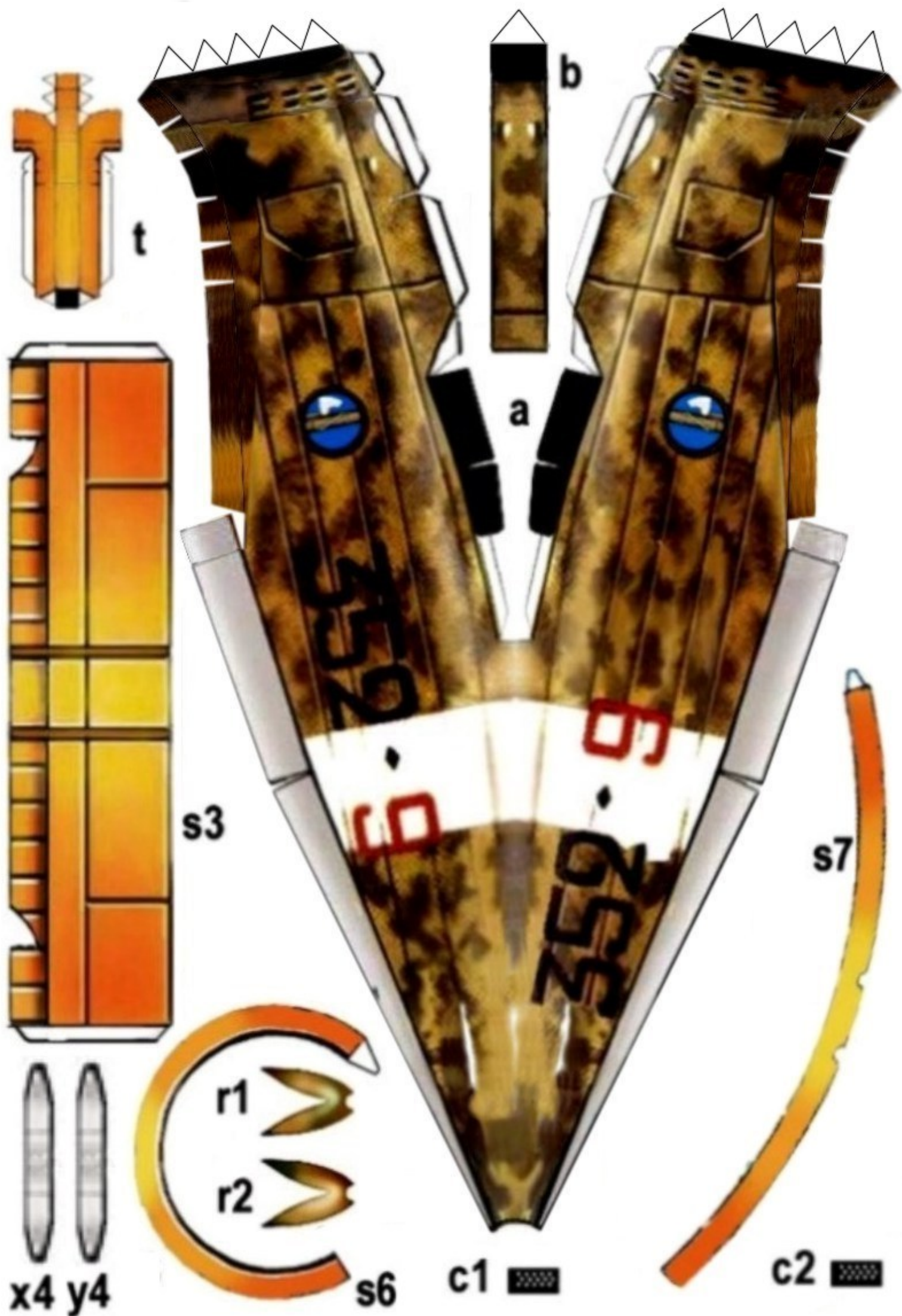

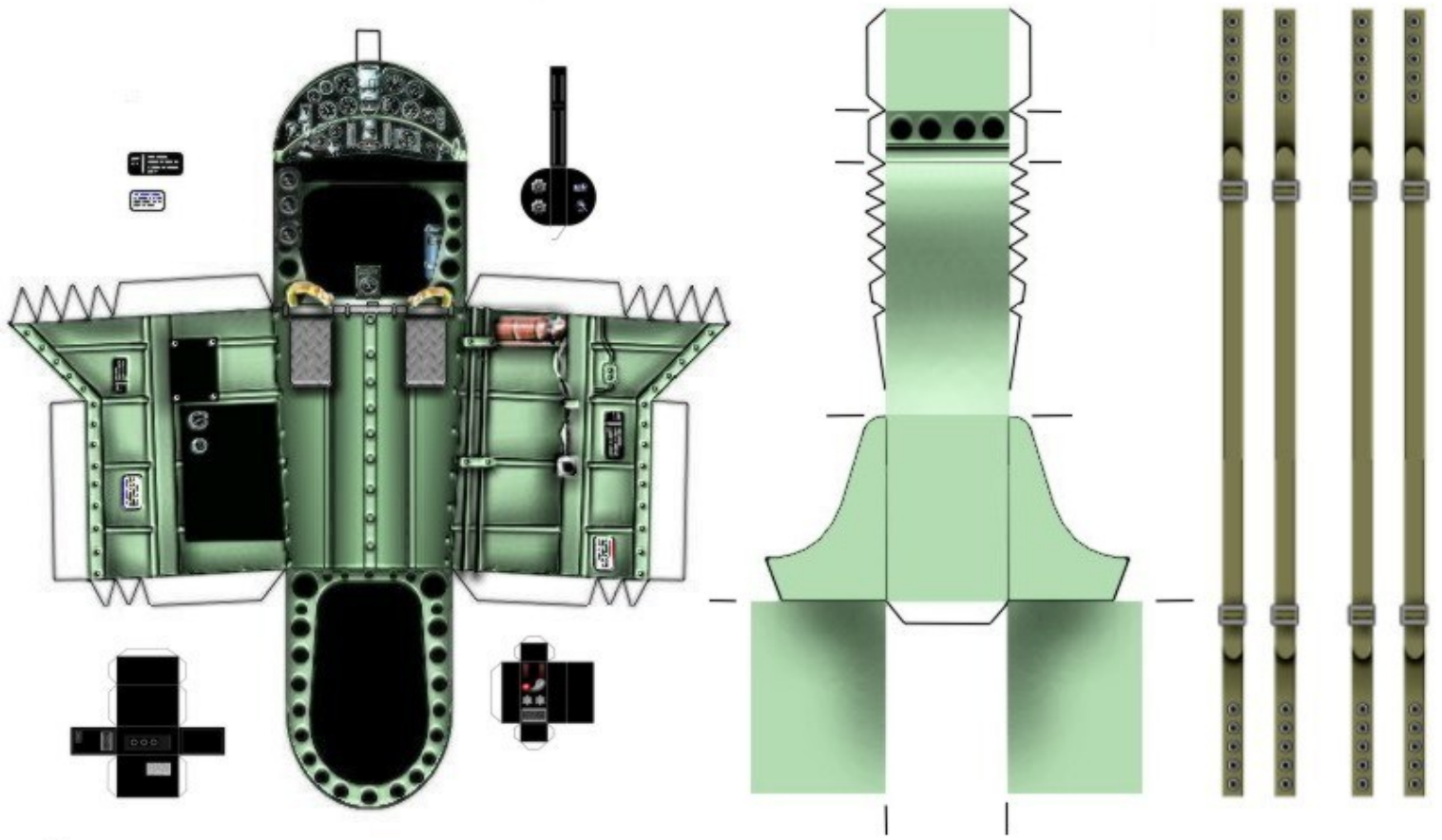

© 2008 by Gabriele Macri

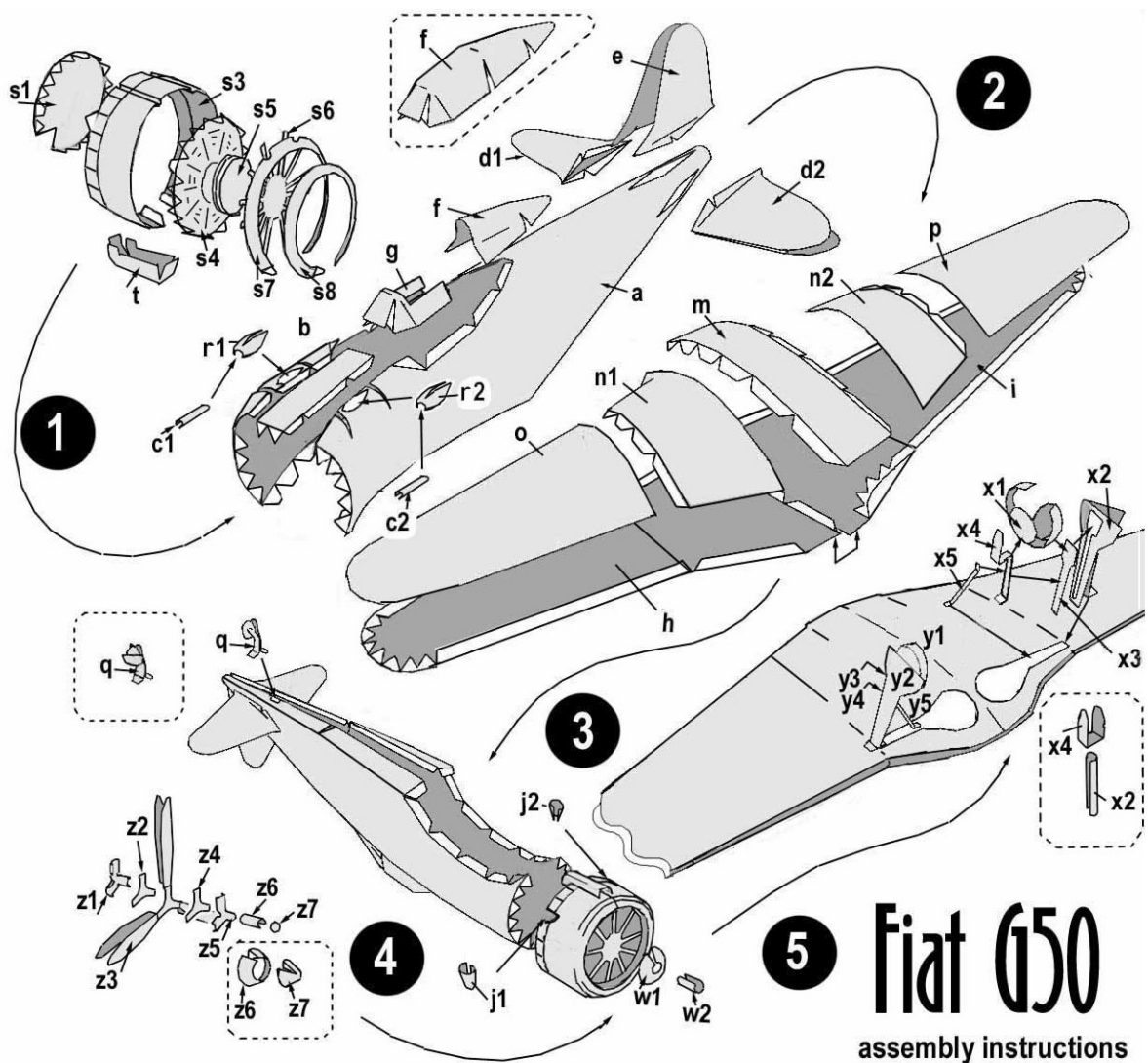

Fiat G50
assembly instructions